

Panasonic

Operating Instructions Instructions d'utilisation Manual de instrucciones

Cordless Impact Driver/Cordless Impact Wrench
Perceuse à impact sans fil/Clé de serrage à impact sans fil
Destornillador de impacto inalámbrico/Llave de impacto inalámbrica

**Model No: EYFLA1A / EYFLA2A
EYFLA2Q / EYFLA3J**

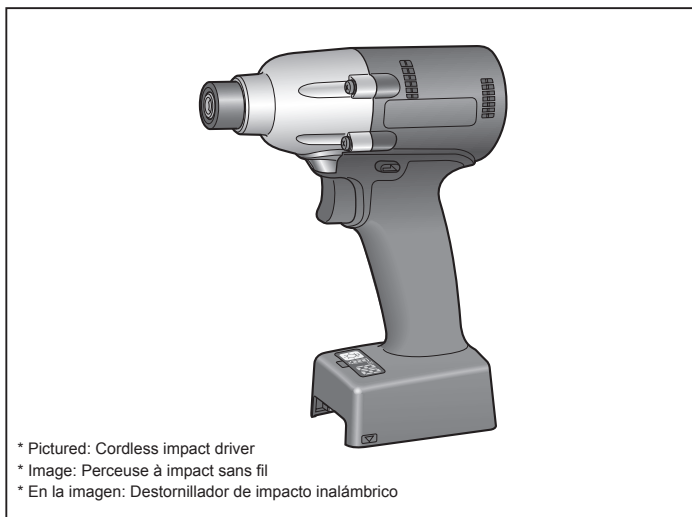

IMPORTANT

This manual contains safety information. Read manual completely before first using this product and save this manual for future use.

IMPORTANT

Ce mode d'emploi contient des informations sur la sécurité. Lisez-le en entier avant d'utiliser le produit et conservez-le pour référence.

IMPORTANTE

Este manual contiene información de seguridad. Lea completamente este manual antes de utilizar por primera vez este producto, y guárdelo para poder consultarlo en el futuro.

Index/Index/Indice

English: Page 4

Français: Page 17

Español: Página 31

FUNCTIONAL DESCRIPTION DESCRIPTION DES FONCTIONS DESCRIPCIÓN FUNCIONAL

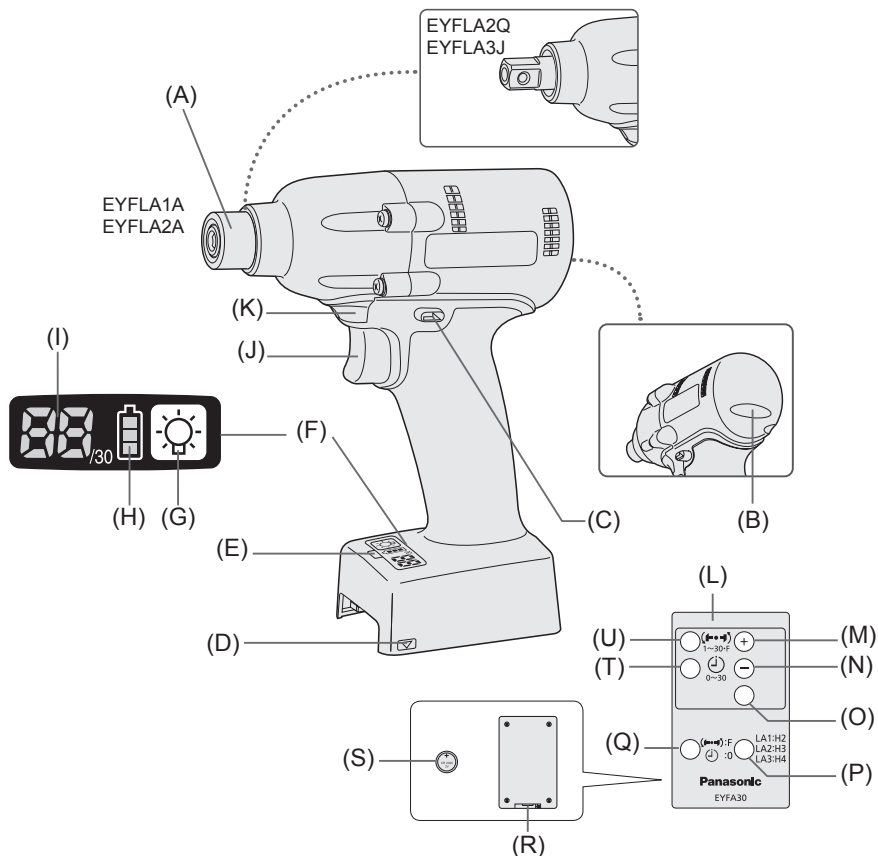

Remote control and battery are not included.
La télécommande et la batterie ne sont pas incluses.
El control remoto y la batería no están incluidos.

(A)	6.35 mm (1/4") hex quick connect chuck (EYFLA1A, EYFLA2A)/square drive (EYFLA2Q, EYFLA3J/Pin type) Mandrin de connexion rapide hexagonal de 6,35 mm (1/4")/entraînement carré (EYFLA2Q, EYFLA3J/Type à goujon) Mandril hexagonal de conexión rápida de 6,35 mm (1/4")/Excitador cuadrado (EYFLA2Q, EYFLA3J/tipo pasador)		
(B)	Tightening confirmation lamp Témoin de confirmation de serrage Lámpara de confirmación de apriete	(C)	Forward/Reverse lever Levier d'inversion marche avant/marche arrière Palanca de avance/marcha atrás
(D)	Alignment mark Marques d'alignement Marcas de alineación	(E)	Remote control receiver Récepteur de la télécommande Receptor de control remoto
(F)	Control panel Panneau de commande Panel de control	(G)	LED light on/off button Bouton Marche/Arrêt de la lumière DEL Botón ON/OFF de luz LED
(H)	Battery indication lamp Témoin indicateur de la batterie Lámpara de indicadora de la batería	(I)	Display Affichage Visor
(J)	Variable speed control trigger Gâchette de commande de vitesse Disparador del control de velocidad variable	(K)	LED light Lumière DEL Luz indicadora
(L)	Remote control Télécommande Control remoto	(M)	+ button Bouton + Botón +
(N)	- button Bouton - Botón -	(O)	OK button Bouton OK Botón OK (correcto)
(P)	Torque level button Bouton de niveau du couple de serrage Botón de palanca de par de torsión	(Q)	Format button Bouton de format Botón de formato
(R)	Holder Support Retenedor	(S)	Battery Batterie Batería
(T)	Interval set button Bouton de réglage de l'intervalle Botón de ajuste de intervalo	(U)	Torque set button Bouton de réglage du couple de serrage Botón de ajuste de par de torsión

I. GENERAL SAFETY RULES

⚠ WARNING! Read all instructions

Failure to follow all instructions listed below may result in electric shock, fire and/or serious injury. The term “power tool” in all of the warnings listed below refers to your mains operated (corded) power tool and battery operated (cordless) power tool.

SAVE THESE INSTRUCTIONS

Work Area Safety

- 1) **Keep work area clean and well lit.**
Cluttered or dark areas invite accidents.
- 2) **Do not operate power tools in explosive atmospheres, such as in the presence of flammable liquids, gases or dust.**
Power tools create sparks which may ignite the dust or fumes.
- 3) **Keep children and bystanders away while operating a power tool.**
Distractions can cause you to lose control.

Electrical Safety

- 1) **Power tool plugs must match the outlet. Never modify the plug in any way. Do not use any adapter plugs with earthed (grounded) power tools.**
Unmodified plugs and matching outlets will reduce risk of electric shock.
- 2) **Avoid body contact with earthed or grounded surfaces such as pipes, radiators, ranges and refrigerators.**
There is an increased risk of electric shock if your body is earthed or grounded.
- 3) **Do not expose power tools to rain or wet conditions.**
Water entering a power tool will increase the risk of electric shock.
- 4) **Do not abuse the cord. Never use the cord for carrying, pulling or unplugging the power tool. Keep cord away from heat, oil, sharp edges or moving parts.**
Damaged or entangled cords increase the risk of electric shock.
- 5) **When operating a power tool outdoors, use an extension cord suitable for outdoor use.**
Use of a cord suitable for outdoor use reduces the risk of electric shock.

Personal Safety

- 1) **Stay alert, watch what you are doing and use common sense when operating a power tool. Do not use a power tool while you are tired or under the influence of drugs, alcohol or medication.**
A moment of inattention while operating power tools may result in personal injury.
- 2) **Use safety equipment. Always wear eye protection.**
Safety equipment such as dust mask, non-skid safety shoes, hard hat, or hearing protection used for appropriate conditions will reduce personal injuries.
- 3) **Avoid accidental starting. Ensure the switch is in the off position before plugging in.**
Carrying power tools with your finger on the switch or plugging in the power tools that have the switch on invites accidents.
- 4) **Remove any adjusting key or wrench before turning the power tool on.**
A wrench or a key left attached to a rotating part of the power tool may result in personal injury.
- 5) **Do not overreach. Keep proper footing and balance at all times.**
This enables better control of the power tool in unexpected situations.
- 6) **Dress properly. Do not wear loose clothing or jewellery. Keep your hair, clothing and gloves away from moving parts.**
Loose clothes, jewellery or long hair can be caught in moving parts.
- 7) **If devices are provided for the connection of dust extraction and collection facilities, ensure these are connected and properly used.**
Use of these devices can reduce dust related hazards.

Power Tool Use and Care

- 1) **Do not force the power tool. Use the correct power tool for your application.**
The correct power tool will do the job better and safer at the rate for which it was designed.
- 2) **Do not use the power tool if the switch does not turn it on and off.**
Any power tool that cannot be controlled with the switch is dangerous and must be repaired.
- 3) **Disconnect the plug from the power source and/or the battery pack from**

the power tool before making any adjustments, changing accessories, or storing power tools.

Such preventive safety measures reduce the risk of starting the power tool accidentally.

- 4) **Store idle power tools out of the reach of children and do not allow persons unfamiliar with the power tool or these instructions to operate the power tool.**

Power tools are dangerous in the hands of untrained users.

- 5) **Maintain power tools. Check for misalignment or binding of moving parts, breakage of parts and any other condition that may affect the power tools operation. If damaged, have the power tool repaired before use.**

Many accidents are caused by poorly maintained power tools.

- 6) **Keep cutting tools sharp and clean.**

Properly maintained cutting tools with sharp cutting edges are less likely to bind and are easier to control.

- 7) **Use the power tool, accessories and tool bits etc. in accordance with these instructions and in the manner intended for the particular type of power tool, taking into account the working conditions and the work to be performed.**

Use of the power tool for operations different from those intended could result in a hazardous situation.

Battery Tool Use and Care

- 1) **Ensure the switch is in the off position before inserting battery pack.**

Inserting battery pack into power tools that have the switch on invites accidents.

- 2) **Recharge only with the charger specified by the manufacturer.**

A charger that is suitable for one type of battery pack may create a risk of fire when used with another battery pack.

- 3) **Use power tools only with specifically designated battery packs.**

Use of any other battery packs may create a risk of injury and fire.

- 4) **When battery pack is not in use, keep it away from other metal objects like paper clips, coins, keys, nails, screws, or other small metal objects that can make a connection from one terminal to another.**

Shorting the battery terminals together may cause burns, or a fire.

- 5) **Under abusive conditions, liquid may be ejected from battery; avoid contact. If contact accidentally occurs, flush with water. If liquid contacts eyes, additionally seek medical help.**

Liquid ejected from the battery may cause irritation or burns.

Service

- 1) **Have your power tool serviced by a qualified repair person using only identical replacement parts.**

This will ensure that the safety of power tool is maintained.

II. INTENDED USE

This tool is a Cordless Impact Driver/Wrench and can be used to tighten bolts, nuts, and screws. Additionally, it provides a torque control function that automatically stops tool operation when a preset load is reached to deliver consistent tightening torque.

Read “the Safety Instructions” booklet and the following before using.

III. ADDITIONAL SAFETY RULES

- 1) **Wear ear protectors when using the tool for extended periods.**

- 2) Be aware that this tool is always in an operating condition, since it does not have to be plugged into an electrical outlet.

- 3) **Hold power tools by insulated gripping surfaces when performing an operation where the cutting tool may contact hidden wiring or its own cord.**



Contact with a “live” wire will make exposed metal parts of the tool “live” and shock the operator.

- 4) Do NOT operate the Forward/Reverse lever when the main switch is on. The battery will discharge rapidly and damage to the unit may occur.

- 5) During charging, the charger may become slightly warm. This is normal. Do NOT charge the battery for a long period.

- 6) When storing or carrying the tool, set the Forward/Reverse lever to the center position (switch lock).

- 7) Do not strain the tool by holding the speed control trigger halfway (speed control mode) so that the motor stops.

Symbol	Meaning
V	Volts
— — —	Direct current
n_0	No load speed
$\dots \text{min}^{-1}$	Revolutions or reciprocations per minutes
Ah	Electrical capacity of battery pack
	Read the operating instructions before use.
	For indoor use only.

IV. ASSEMBLY

Attaching or Removing Bit

NOTE:

- When attaching or removing a bit, disconnect battery pack from tool or place the switch in the center position (switch lock).
- Hold the collar of quick connect chuck and pull it out from the tool.
 - Insert the bit into the chuck. Release the collar.
 - The collar will return to its original position when it is released.
 - Pull the bit to make sure it does not come out.
 - To remove the bit, pull out the collar in the same way.

CAUTION:

- If the collar does not return to its original position or the bit comes out when pulled on, the bit has not been properly attached. Make sure the bit is properly attached before use.

EYFLA1A/EYFLA2A

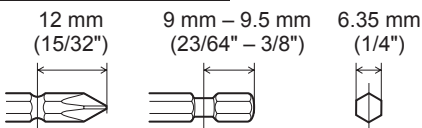

Attaching Socket

- Remove the socket's rubber ring and pin.

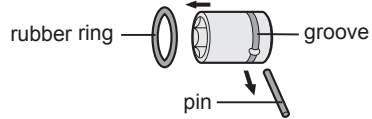

- Attach the socket to the tool.
- Insert the pin. (Taking care to align the pin holes on the socket and tool.)
- Attach the rubber ring by sliding it into place over the groove.

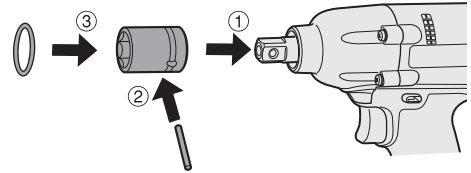

NOTE:

Be sure to attach the rubber ring to prevent the pin from falling out.

Removing Socket

- Remove the rubber ring.
- Remove the pin.
- Remove the socket from the tool.

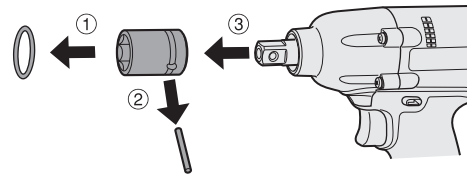

NOTE:

Keep the temperature of the tool above the freezing point (0°C/32°F) when attaching sockets to or detaching them from the square drive on the tool. Do not use excessive force when attaching or detaching sockets.

Attaching or Removing Battery Pack

- To connect the battery pack:
 - Line up the alignment marks and attach the battery pack.
 - Slide the battery pack until it locks into position.

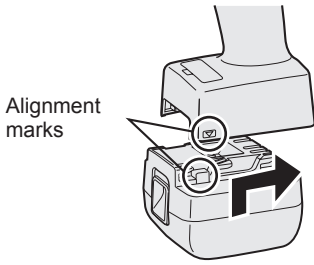

- To remove the battery pack:
Push up on the button from the front to release the battery pack.

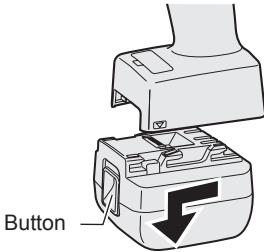

V. OPERATION

Before Using the Remote Control (Available as an optional accessory)

Insert the battery

- Pull out the battery holder.

- Push in on the fastener as indicated by the arrow.
- Pull out the holder.

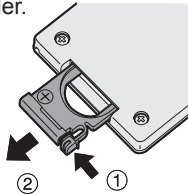

- Insert the battery and push the holder back in.

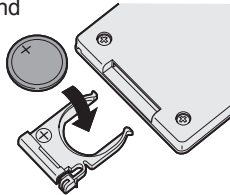

NOTE:

- If the tool does not respond to the wireless remote control even when the remote control is operated close to the tool, the battery (CR2025) is dead. Replace it with a fresh battery.
- The included battery is provided for sample use and may not last as long as commercially available batteries.

Wireless remote control range

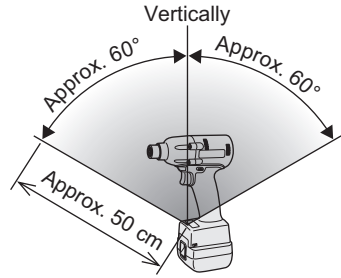

The remote control should be operated within approximately 50 cm and approximately 60° vertically and horizontally of the perpendicular relative to the infrared receiver on the tool.

- Under the following circumstances, you may not be able to operate the tool, even within this range.
 - If there is an object between the remote control's transmitter and the tool's receiver.
 - Use outdoors or in other environments where the remote control receiver is exposed to a strong light source, or when the remote control transmitter or receiver is dirty may cause the tool to fail to respond, even when the remote control is used within the operating range.

[Main Body]

Switch and Forward/Reverse Lever Operation

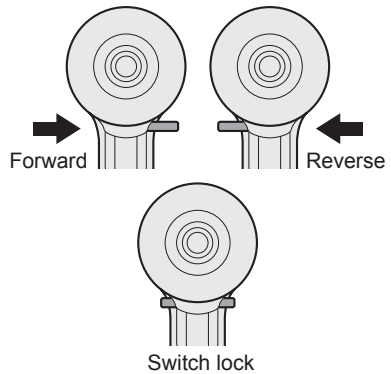

CAUTION:

To prevent damage, do not operate Forward/Reverse lever until the bit comes to a complete stop.

Forward Rotation Switch Operation

1. Push the lever for forward rotation.
2. Depress the trigger switch slightly to start the tool slowly.
3. The speed increases with the amount of depression of the trigger for efficient tightening of screws. The brake operates and the bit stops immediately when the trigger is released.
4. After use, set the lever to its center position (switch lock).

Reverse Rotation Switch Operation

1. Push the lever for reverse rotation. Check the direction of rotation before use.
2. Depress the trigger switch slightly to start the tool slowly.
3. After use, set the lever to its center position (switch lock).

CAUTION:

- To eliminate excessive temperature increase of the tool surface, do not operate the tool continuously using two or more battery packs. Tool needs cool off time before switching to another pack.

Tightening confirmation lamp

- The tightening confirmation lamp can be used to check whether the torque control function was activated.

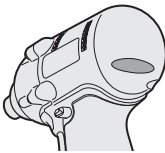

Tool status	Lamp display
Tightening complete (with torque control function operation)	Green (For approx. 2 seconds)
<ul style="list-style-type: none"> • Tightening not complete • Tightening complete with retightening within 1 second 	Red (For approx. 2 seconds)
The automatic stop function has been activated.	Red (For approx. 5 minutes)

CAUTION:

- When the tool stops automatically after the switch is released during impact-mode tightening and then re-engaged within 1 second, the red lamp will light up to indicate the risk of excessive torque application as a result of re-tightening.

NOTE

- The tightening confirmation lamp will not turn on under the following conditions:
 - When the torque clutch is set to "F"
 - During reverse rotation operation
 - The lamp turns off when the tool is in operation.

Control Panel

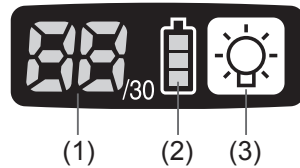

(1) LED light

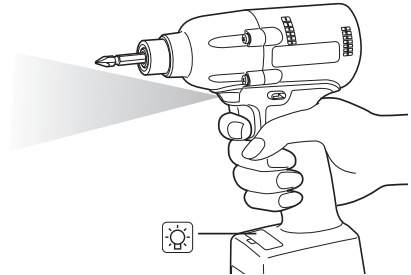

Pressing the  button toggles the LED light on and off.

The light illuminates with very low current, and it does not adversely affect the performance of the tool during use or its battery capacity.

CAUTION:

- The built-in LED light is designed to illuminate the small work area temporarily.
- Do not use it as a substitute for a regular flashlight, since it does not have enough brightness.

This tool has the built-in LED light.

Caution: DO NOT STARE INTO BEAM.

Use of controls or adjustments or performance of procedures other than those specified herein may result in hazardous radiation exposure.

(2) The battery indication lamp

- Use the battery indication lamp to check how much power is left in the battery.
- Battery life varies slightly with ambient temperature and battery characteristics. The lamp is designed to provide a rough indication of remaining battery life.

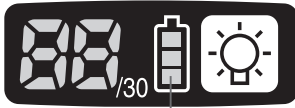

Battery indication lamp

Indicator	Battery status
	Fully charged
	Approx. 40% or less remaining
 Flashing	Flashing Approx. 20% or less remaining (indicates need to recharge battery) The battery pack will need to be charged soon.
 Flashing	No charge The battery pack needs to be charged. (The tool's automatic power-off function will activate at this stage.)

Automatic power-off function

- The automatic power-off function is designed to prevent a loss of tightening torque due to reduced battery voltage. Once it has been activated, the tool will not operate until the battery pack has been charged (or replaced with a fresh unit), even if the trigger is depressed.



Battery indication lamp

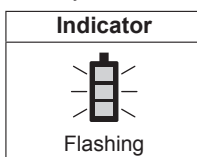

NOTE:

- All 3 bars on the battery indication lamp will flash when the automatic power-off function is activated.
- When the battery indication lamp begins flashing, the battery pack should be charged (or replaced with a fresh unit) immediately.
- Be sure to fully charge the battery pack in question after activation of the automatic power-off function. Failure to do so may prevent the automatic power-off function from being properly deactivated.

(3) The torque control function

- The torque control function calculates the load from the motor's rotational angle during the hammer impact and determines that the bolt has been properly seated when a pre-set load value is exceeded. Driving is then automatically stopped after a preset number of impacts have been delivered to the bolt.

CAUTION:

- Always check the tool's tightening torque before use. Improper tool operation may result in excessive or inadequate tightening.

CAUTION:

- Always operate the tool with the switch fully engaged. The torque control function will not operate when the switch is not sufficiently engaged, preventing the tool from stopping automatically.
- In work where a heavy load comes to bear during tightening, the load may be interpreted as the seating of the bolt, preventing the bolt from being completely tightened.
- Repeated tightening of the same bolt may break the bolt or deform the material into which the bolt is being driven as a result of excessive tightening.
- The tightening torque value and precision vary with factors such as the material into which the bolt is being driven and the condition of the socket being used. Adjust the torque as necessary for the work being performed. Bolt tightening torque varies due to the factors described below.



1) Bolt

- Bolt diameter: Tightening torque generally increases with bolt diameter.
- Torque coefficient (indicated by the bolt manufacturer), grade, length, etc.

2) Other

- Bit and socket condition: Material, amount of play, etc.
- Use of a universal joint or socket adapter
- User: Manner in which the tool is applied to the bolt, strength with which the tool is held, manner in which the tool's switch is engaged
- Condition of object being tightened: Material, seating surface finish

Setting the tool to configuration mode

1. Turn off the control panel.
 - If the control panel is on, remove and then reinsert the battery pack.
2. Engage the switch while pushing the  button and then release both the  button and the switch.
 - After all the LED lamps have turned off, the control panel will flash and change to configuration mode.

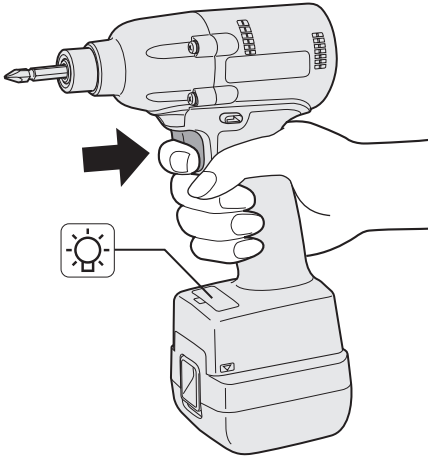

NOTE:

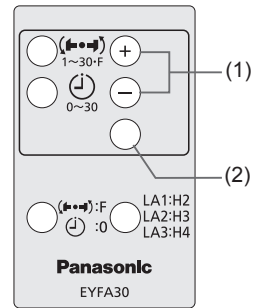
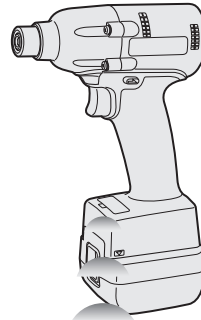

- Tools ship from the factory set to "F" mode (torque control function off).
- The control panel will turn off if the tool is not operated for a period of 5 minutes.

Configuring the torque clutch setting



Display

Battery indication lamp

1. Press the  and  buttons to select the clutch setting that is appropriate for the work being performed.

As the  button is pressed

As the  button is pressed

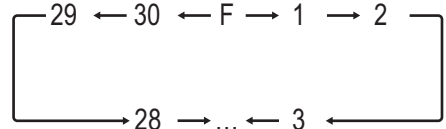

- "F" indicates that the torque control function is off.

- You can select from 30 torque clutch settings (1 to 30).
- Use figures from the Tightening Torque Chart to guide your selection of torque clutch setting. (See the following tightening torque chart)

2. Press the OK button to accept the selected torque clutch setting.
 - The control panel will stop flashing and light up.

CAUTION:

- You must press the OK button in order for the selected setting to take effect.
- Be sure to verify the new value after changing the setting. (See page 11.)

Tightening Torque Chart (for Reference Use)

The values illustrated on this chart were measured under the conditions described below and are provided for reference purposes. Actual tightening torque varies with ambient conditions (the particular bolt being tightened, hardware being used, method of holding the bolt in place, etc.).

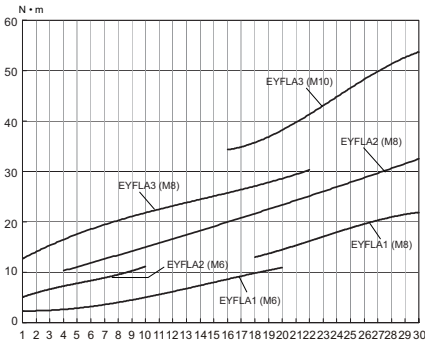

Measurement conditions

- Temperature: Room temperature (20°C/68°F)

Using the Interval Set

- The interval set operates to prevent the tool from operating after it automatically stops as a result of the torque control function, even if the switch is engaged.

1. Set the tool to configuration mode. (See page 10.)
2. Press the interval set button.
 - The control panel will begin flashing.
 - Display: The number 0 flashes on and off.
 - Battery indication lamp: The middle bar of the battery flashes on and off.



Display

Battery indication lamp

3. Press the + and - buttons to set the desired time.

Buttons	Display	Seconds
	30	3
	:	:
	1	0.1
	0	Off

4. Press the OK button to accept the selected setting.
 - The control panel will stop flashing and light up, and the torque clutch setting will be displayed.

CAUTION:

- Be sure to verify the new value after changing the setting.

Initializing All Settings

Factory settings

- Torque clutch setting: "F" (torque control function off)
- Interval setting: 0 (off)

- This section explains how to revert all tool settings to their default values at the time of shipment from the factory.
- The error display will be turned off.

1. Set the tool to configuration mode. (See page 10.)
2. Press the format button.

- The control panel will begin flashing.
- Display: The letter "F" flashes on and off.
- Battery indication lamp: The upper and lower bars of the battery flash on and off.



Display

Battery indication lamp

3. Press the OK button to accept the selected setting.
 - The control panel will stop flashing and light up.

Checking Tool Settings

- This section describes how to have the tool display current settings for approximately 3 seconds when the tool is stopped.
- You cannot check tool settings when the control panel is turned off. First, engage the switch briefly to reactivate the display.

Checking the torque clutch setting

1. Press the torque set button.
 - Control panel display
Display: The torque set lights up.
Battery indication lamp: The upper bar of the battery flashes on and off.

Checking the interval

1. Press the interval set button.
 - Control panel display
Display: The interval set lights up.
Battery indication lamp: The middle bar of the battery flashes on and off.

Checking tool circuits

1. Press the torque set button.
 - Control panel display
Display: The torque set display lights up.
Battery indication lamp: The middle and lower bars of the battery flash on and off.

Display	Tool circuit
H2	EYFLA1
H3	EYFLA2
H4	EYFLA3

NOTE:

- If you engage the switch while a setting is being displayed, the control panel will revert to the torque clutch setting display.

CAUTION:

- The torque set display is not intended to be used to identify the type of drive component parts (hammer, etc.) used in a particular tool.

Error Display

In the event of a tool or battery pack malfunction, the control panel will display an error message. Please check the tool or battery pack as described in the following chart before having them serviced.

Display	Likely cause	Corrective action
E1	Setting error	Re-initialize the tool using the remote control. (See page 12.)
E2	The battery pack is too hot.	Stop work and allow the battery pack to cool before resuming use of the tool.
E3	The tool is too hot to operate.	Stop work and allow the tool to cool before resuming use.
E4	The contacts that connect the battery pack and tool are dirty.	Remove any dirt.
	The battery pack has not been properly inserted into the tool.	Insert the battery pack firmly into the tool.
	The pins on either the tool or battery pack have worn down.	Replace the battery pack.
E5	Motor failure, etc.	Stop using the tool immediately.
E6	Sensor malfunction, failure, etc.	
E7	Tool circuit malfunction, failure, etc.	

[Battery Pack]

For Appropriate Use of Battery Pack

Li-ion Battery Pack (EYFB30)

- For optimum battery life, store the Li-ion battery pack following use without charging it.
- When charging the battery pack, confirm that the terminals on the battery charger are free of foreign substances such as dust and water etc. Clean the terminals before charging the battery pack if any foreign substances are found on the terminals. The life of the battery pack terminals may be affected by foreign substances such as dust and water etc. during operation.

- When battery pack is not in use, keep it away from other metal objects like: paper clips, coins, keys, nails, screws, or other small metal objects that can make a connection from one terminal to another. Shorting the battery terminals together may cause sparks, burns or a fire.
- When operating the battery pack, make sure the work place is well ventilated.
- When the battery pack is removed from the main body of the tool, replace the battery pack cover immediately in order to prevent dust or dirt from contaminating the battery terminals and causing a short circuit.

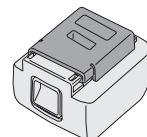

Battery Pack Life

The rechargeable batteries have a limited life. If the operation time becomes extremely short after recharging, replace the battery pack with a new one.

Battery Recycling

ATTENTION:

FOR Li-ion Battery Pack, EYFB30

A Li-ion battery that is recyclable powers the product you have purchased.

Please call **1-800-8-BATTERY** for information on how to recycle this battery.



[Battery Charger]

Charging

Read the operating manual for Panasonic battery charger for the battery pack before charging.

Before charging the battery

When charging EYFB30:

Charge the battery at a temperature of 5°C (41°F) to 40°C (104°F).

The battery pack cannot be charged at a temperature of less than 5°C (41°F). If the temperature of the battery pack is less than 5°C (41°F), first remove the battery pack from the charger and allow it to sit for an hour in a location where the temperature is 5°C (41°F) or warmer. Then charge the battery pack again.

VI. MAINTENANCE

Use only a dry, soft cloth for wiping the unit. Do not use a damp cloth, thinner, benzine, or other volatile solvents for cleaning.

VII. ACCESSORIES

Charger

- EY0L80

Battery pack

- EYFB30

Remote control

- EYFA30

Protector for tool

- EYFA01-A (Blue)
- EYFA01-Y (Yellow)
- EYFA01-H (Gray)

Protector for battery

- EYFA02-H

VIII. SPECIFICATIONS

MAIN UNIT

Model		EYFLA1		EYFLA2		EYFLA3
		A		A	Q	J
Moter		10.8 V DC				
Chuck size	Single-ended	9 – 9.5 mm (23/64" – 3/8")		9 – 9.5 mm (23/64" – 3/8")	□9.5 mm (3/8")	□12.7 mm (1/2")
	Double-ended	12 mm (15/32")		12 mm (15/32")		
No load speed	Stage	1	0 – 950	1	0 – 1300	0 – 2300
		2	0 – 1000	2	0 – 1450	
		3 – 5	0 – 1050	3	0 – 1550	
		6	0 – 1300	4 – 30·F	0 – 2300	
		7	0 – 1450			
		8	0 – 1550			
		9 – 30·F	0 – 2300			
Impact per minute	Stage	1	0 – 1900	1	0 – 2500	0 – 3000
		2	0 – 1950	2	0 – 2800	
		3 – 5	0 – 2100	3	0 – 3000	
		6	0 – 2500	4 – 30·F	0 – 3600	
		7	0 – 2800			
		8	0 – 3000			
		9 – 30·F	0 – 4000			
Maximum torque		40 N·m (408 kgf-cm, 354 in-lbs)		90 N·m (918 kgf-cm, 796 in-lbs)		120 N·m (1224 kgf-cm, 1062 in-lbs)
Torque control function operating range		Approx. 3 – 22 N·m (31 – 224 kgf-cm, 27 – 195 in-lbs)		Approx. 6 – 30 N·m (61 – 306 kgf-cm, 53 – 266 in-lbs)		Approx. 16 – 53 N·m (163 – 540 kgf-cm, 142 – 469 in-lbs)
Overall length		158 mm (6-7/32")			164 mm (6-7/16")	
Weight (with battery pack: EYFB30)		1.3 kg (2.8 lbs)				1.35 kg (2.9 lbs)

BATTERY PACK (not included with shipment)

Model	EYFB30
Storage battery	Li-ion battery
Battery voltage	10.8 V DC (3.6 V/6 cells)
Capacity	3 Ah

BATTERY CHARGER (not included with shipment)

Model	EY0L80
Rating	See the rating plate on the bottom of the charger.
Weight	0.95 kg (2.1 lbs)

[Li-ion battery pack]

Charging time	3 Ah	10.8 V
		EYFB30
		Usable: 40 min.
		Full: 65 min.

Remote control (not included with shipment)

Model	EYFA30
Battery voltage	3 V DC
Dimensions	54 mm (2-1/8") × 86 mm (3-3/8") × 10 mm (13/32")
Weight (with battery)	Approximately 29 g (0.6 lbs)